

The image features a large, circular, light red watermark in the background. The watermark contains the text "ALFA ROMEO" at the top and "GT JUNIOR" in a stylized font below it. The background is a solid, dark red color. Overlaid on this is the text "GT Junior" in a large, bold, white sans-serif font, with "1.6" positioned directly below it in the same style.

GT Junior
1.6

Cars in the 100-110 m.p.h. range are commonplace nowadays: such are the benefits of modern technology. But it is one thing to be able to drive fast, and quite another to be able to do so under optimal safety conditions; in other words there is a big difference between a highly-

tuned ultralight vehicle for which everything – strength, flexibility, solidity – has been sacrificed in favour of pure speed, and a well-balanced, « powerful » vehicle, with a high acceleration capacity at all speeds, with a low-revving engine capable not only of bursts of very high

speeds, but of maintaining these speeds over long distances, and in which everything – transmission, suspension, brakes and comfort – is matched to the power of the engine.

The Alfa Romeo GT Junior has been produced by designers who have tradi-



tionally worked to much greater safety margins than those required by the top performance of the vehicle. The result is that because of their inherent strength, durability and roadability, the vehicles are much more reliable than the average car. This brings us to the famous Alfa Romeo

« reserve » of acceleration and safety: for even at the highest cruising speeds, the driver of a GT Junior always has a considerable reserve of emergency acceleration, and even at the highest speed of which the car is capable, he can still count on this inherent strength and road-

holding which are well above the limitations of other cars.



GT Junior

1.6



That special and unique « something » that every Alfa Romeo possesses no doubt derives from the methodical and systematic application to ordinary road cars, of features worked out on the race track. The G.T. Junior 1.6 is a living proof

of this. Its design characteristics are a list of these features:

- engine design allows it to give the maximum specific output at low revs (hemispherical combustion chambers, direct valve operation by 2 overhead

- camshafts). Light alloy cylinder block. Sodiumcooled exhaust valves;
- intake and exhaust systems designed for the maximum filling of the combustion chambers. Fuel feed via two twin choke carburettors, one per cylinder;





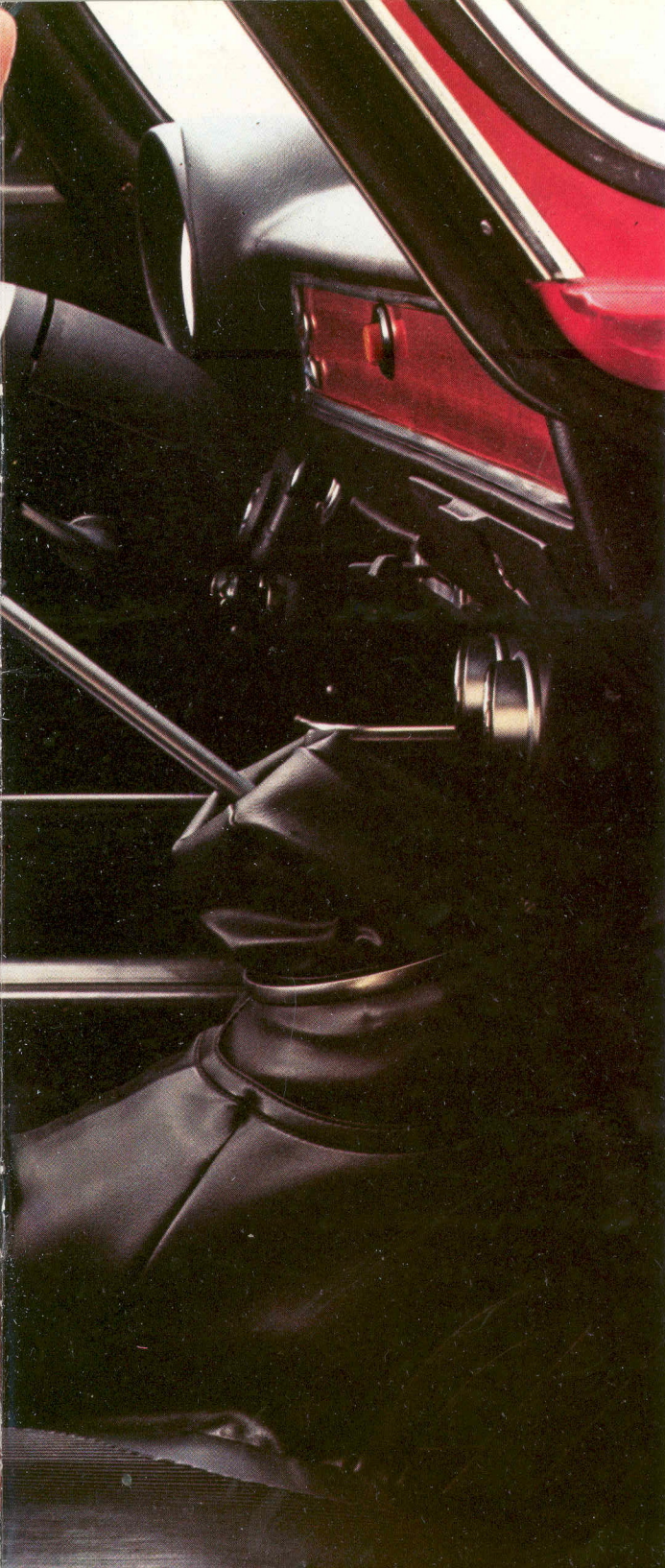

- the design of the steering system;
- 5-speed synchromesh gearbox;
- the driving positions and the layout of the controls;
- the body style;
- reduced weight on the rear axle: differential casing of light alloy;
- the braking system.

These characteristics do not simply result in speed alone, but in high speeds at normal revs under optimal safety conditions. Such are the unique technical features of the GT Junior and all Alfa Romeos.

Power

Of all cars of this cylinder capacity, the GT Junior has the greatest margin, at any speed, between power available and power actually used. For example, at a speed of 80-85 m.p.h., the GT Junior uses only half its engine power, leaving the rest available for acceleration. Its revs at this speed are in the 4600/4800 range. Using such low revs increases the life of the engine and reduces fuel consumption.

Road-holding

Road-holding has always been one of Alfa Romeo's strong points: it is achieved by a combination of balancing weight distribution, careful design of the suspension, and various technical features gathered together through years of racing experience. Stability is assured at any speed and on any road. Moreover, the vehicle is always easy to handle and quick to respond, thus enabling any situation to be corrected and brought under control. This is the reason for the loyalty and enthusiasm of Alfa Romeo owners towards their cars.

Braking

This is another well known Alfa Romeo

advantage. The GT Junior has twin-circuit servo-assisted brakes with a braking power regulator on the rear wheels. When braking on a slippery road or during any violent braking, this regulator keeps the vehicle under control. The braking power, its progressive action and the continuity of its efficiency are all due to the diameter of the discs (10.5 ins) and their total braking surface of 351.6 sq.ins. A far from unimportant safety feature is the fact that the emergency handbrake is completely independent and works on its own rear-wheel drums.



Protective safety

The mechanical parts of the vehicle are generously dimensioned, the structure of the bodywork is reinforced with ribs and cross-members, and the suspension is designed to stand up to bends taken at speed and to heavy braking. It is also worth mentioning that the design of the body shell is based on a system whereby

the extremely rigid passenger compartment is structurally differentiated from the front and rear sections which will buckle so as to absorb the impact of a collision thus protecting the occupants. The stresses of the race track and the destructive testing of vehicles at the Balocco test track and in the experimental workshops guarantee the built-in safety of every bright new GT Junior which comes of the production line.

Comfort

The passenger compartment of the GT Junior is insulated by a sound-absorbent layer of padding from dashboard to boot, which is as much as $\frac{3}{4}$ in. thick at the structural support points. Engine noise is eliminated at gearbox level by the adoption of silent bloc mountings. The hydraulic operation of the clutch also reduces noise. Quietly listening to the radio or talking has always been possible in saloon cars, and a problem in the case of GT sports models – but one which Alfa Romeo has now resolved. The seat arrangement gives a comforta-

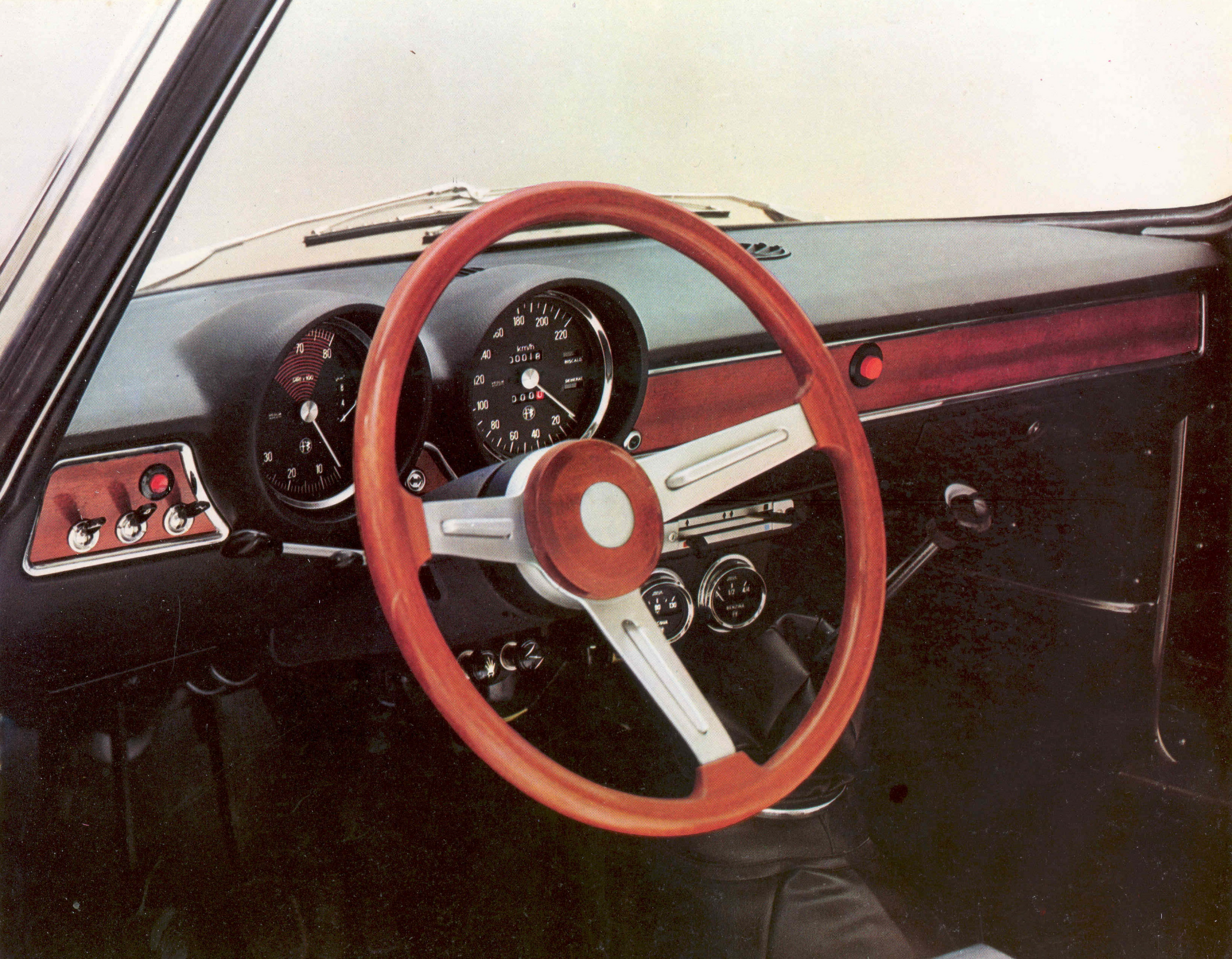

Instrument cluster containing a tachometer on the left and a speedometer on the right. The speedometer scale ranges from 0 to 220 km/h. The odometer displays 00018. The tachometer scale ranges from 0 to 80. The gauges feature a red needle and a black face with white markings.

Control panel with three toggle switches and a red master battery disconnect switch. The panel is mounted on the left side of the dashboard.

Two smaller circular gauges located below the main instrument cluster, likely for oil pressure and water temperature.





EE 1
7220

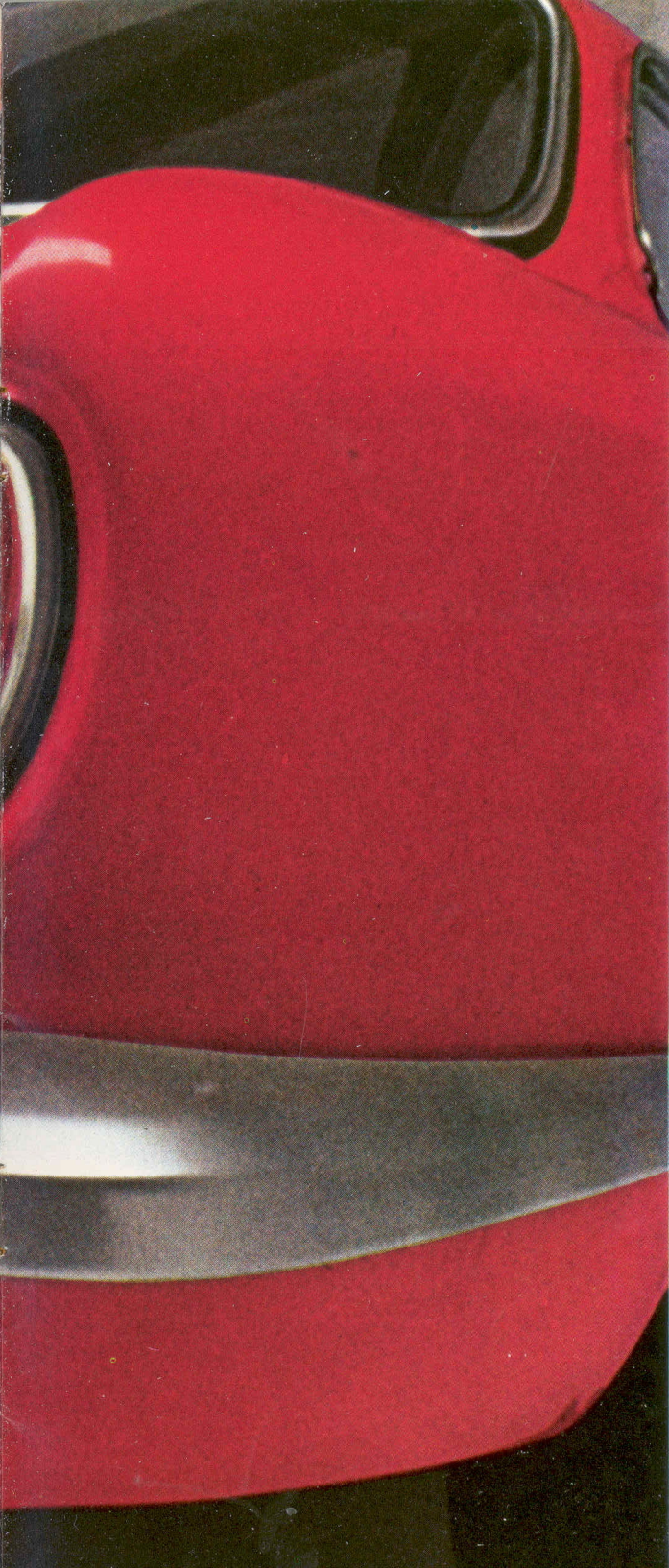

ble driving position with a natural pedal action and easy gear changing. The wrap-around design of the back rest like the seat cushion itself, supports the driver so that he cannot lose his position even on the sharpest bends. The back seats will accommodate two people with a degree of comfort exceptional for a coupé. The finish is in keeping with the elegance of the vehicle. The dashboard is made of anti-impact material faced with real wood. It contains all the necessary instruments

which are very easy to read; furthermore, the controls are comfortably within reach, which is an important safety feature at high speeds. The windscreen wipers are 2 speed and are both hand and foot operated; the steering wheel is of a modern design and incorporates the horn buttons. The GT Junior also has an anti-theft steering lock and a push-in cigar lighter. The ventilation and heating system now has a special air-mixing device and a 2-speed fan.

Alfa Romeo means safety - Alfa Romeo boasts many special features and advantages over the rest of the motor industry. Speed, acceleration, road-holding, brakes — all these are combined in every Alfa Romeo produced; add to these: fuel economy, quietness and comfort. And all these combine to give the high Continental motorway speeds that Alfa Romeo consider normal. These are features which, by improving the efficiency of the vehicle and by keeping the driver relaxed, give an unrivalled degree of safety on the road.

Even at high speeds, an Alfa Romeo is safer - An Alfa Romeo only uses half its available engine power to get up to what are already high speeds (80-85 m.p.h.). There is still plenty of accelera-

tion in reserve, even in fifth gear. In comparative road-holding tests, the stability of an Alfa Romeo has no rival. It is a miracle of balance, design, weight distribution and of calculated reaction of springs and anti-roll bars, backed by many years' racing and achieved by a test team with over 60 years' experience behind them.

The braking efficiency of an Alfa Romeo does not fade, however long, violently or repeatedly the brakes are applied. This is because of the structure of the disc brakes, and of a design and inherent strength which protects them from deformity caused by their principal enemy, heat. Moreover, they are generously dimensioned and equipped with a braking power regulator on the rear wheels.

For the same cylinder capacity, an Alfa Romeo is more powerful - An Alfa Romeo engine has a compression ratio of 9 : 1. This is not a particularly high ratio, and in fact is no higher than many compression ratios in common use nowadays but it helps to extend the life of the engine. Nevertheless, the engine itself has a very high specific output.

The reasons for this are as follows.

The intake manifolds are designed to prevent wastage. Consequently there is a constant mixture flow and the cylinders are fully filled. The valves are operated directly by two camshafts without any intervening mechanical parts such as rods, rocker arms, etc., which detract from both timing accuracy and operating smoothness. Flame propagation is smooth and combustion total, because the combustion chambers are hemispherical with the plugs at the centre.

The burnt gases are discharged through exhaust manifolds which have been designed with the same care as the intake manifolds. Constant and complete filling, total combustion, rapid exhaust-

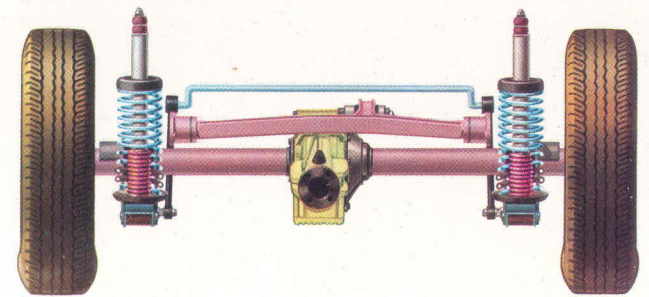
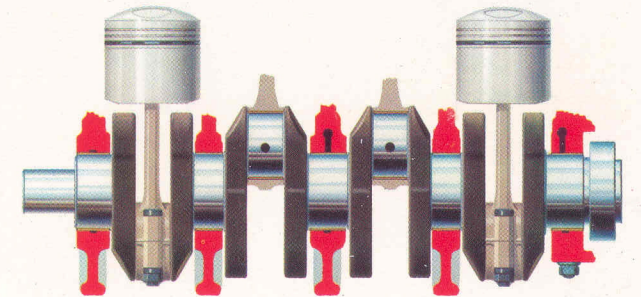
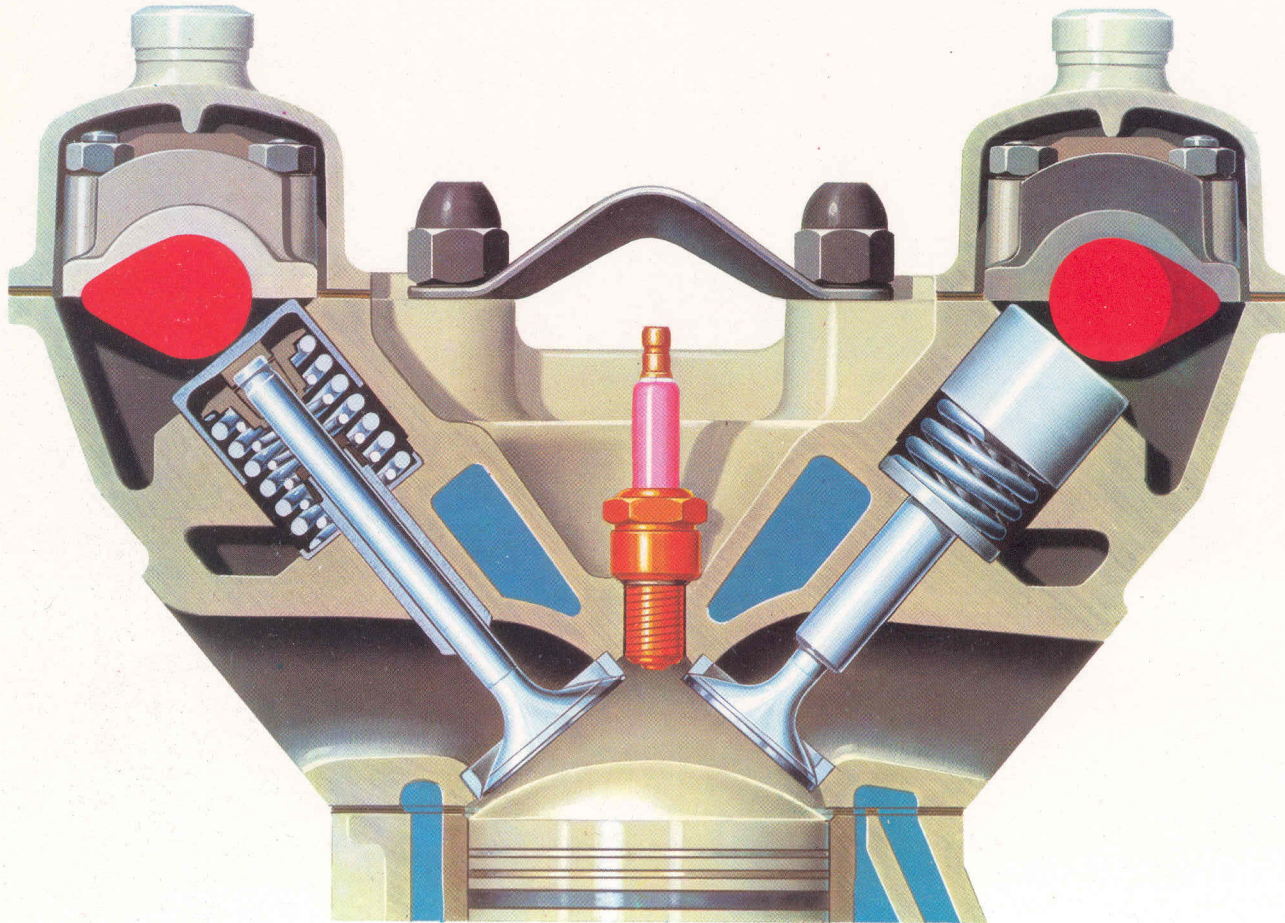

ting: these are the reasons why Alfa Romeo engines have more power per cc. This complete combustion, with no wastage, also results in the well-known Alfa Romeo fuel economy.

The full power of an Alfa Romeo is not all concentrated around 4,500 RPM. On the contrary, it is spread over the whole engine speed range, backed up by the 5-speed gearbox. Not only, therefore, will an Alfa Romeo get up to very high speeds, but it will reach them very quickly. This enables the driver to be first away at the lights and to overtake in complete safety.

The 5th gear is another Alfa Romeo speciality, because it is not simply an added gear or « over-drive ». Of course it helps to save fuel on the open road, but above all, it must be stressed that it is a useful gear, with genuine acceleration ability, designed to meet present-day motoring requirements where acceleration may be needed even at high motorway speeds.

Even with higher performance, an Alfa Romeo lasts longer than other cars - The maximum revs of an Alfa Romeo engine are in the 5500/6000 range: at these revs no strain is put on the engine and top road speeds can be maintained over long periods. Moreover, an Alfa Romeo will reach high cruising speeds with the engine running at only 4000/4500 RPM.

The crankshaft has not the normal 3, but 5 bearings. Consequently there is no vibration, even at high engine speeds.

Finally, keeping the engine cool is the only way of ensuring that it will constantly deliver the required output:

- Alfa Romeo engines dissipate heat quickly because the cylinder block, cylinder head and sump are of light alloy material, rather than cast-iron;
- the cylinder liners are in direct contact with the water in the cooling system;
- the exhaust valves are capable of keeping their own temperature down, being sodium cooled.

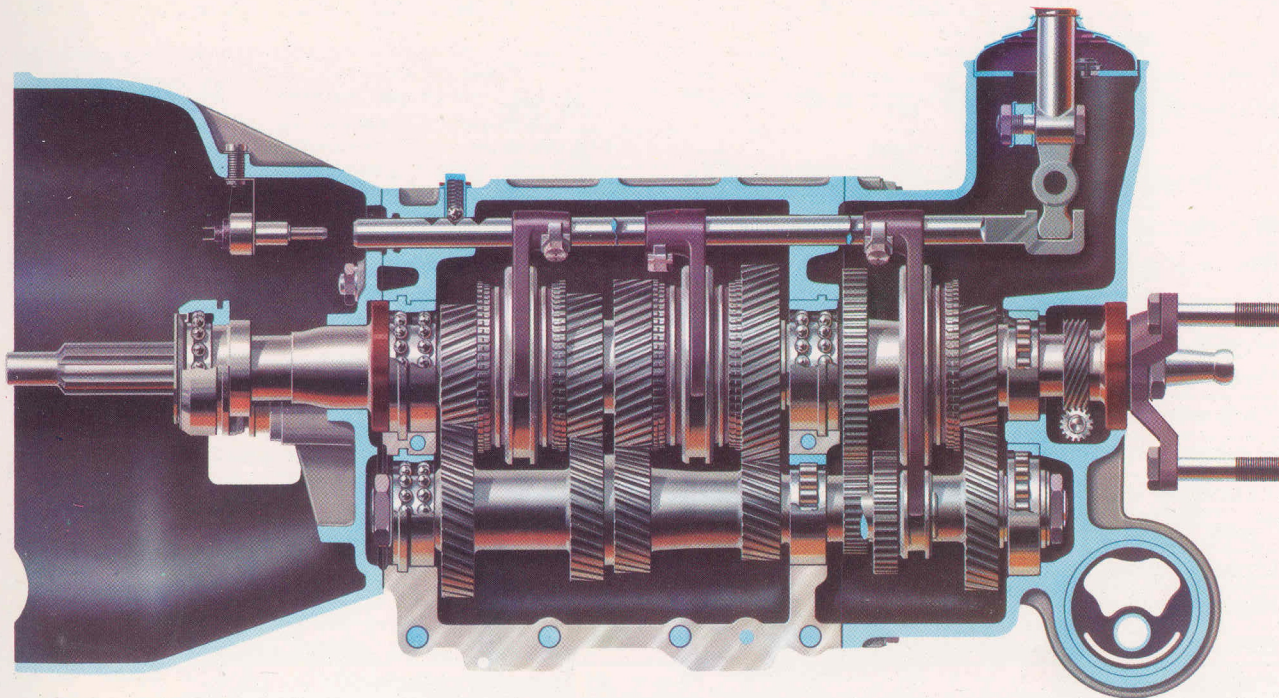
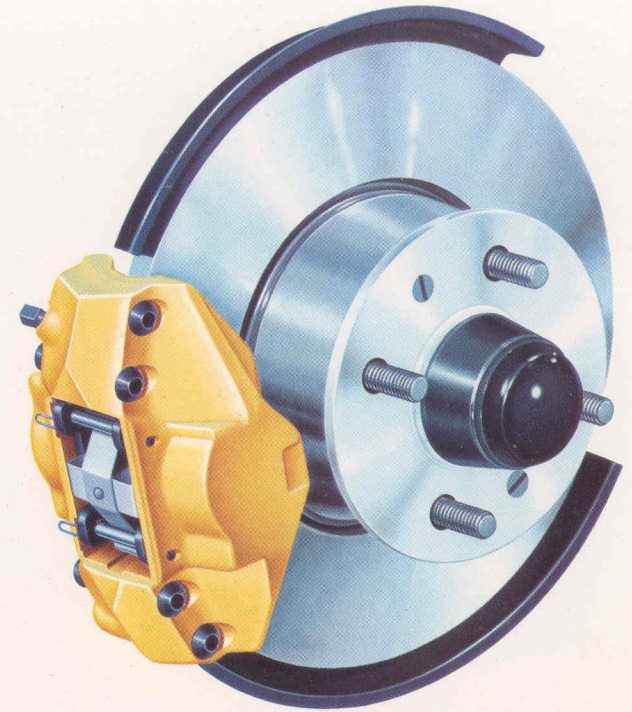

Normal valve

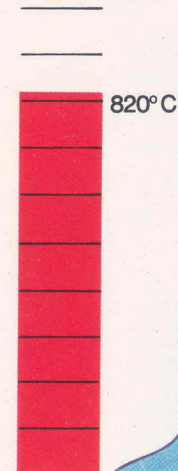

Sodium-cooled valve

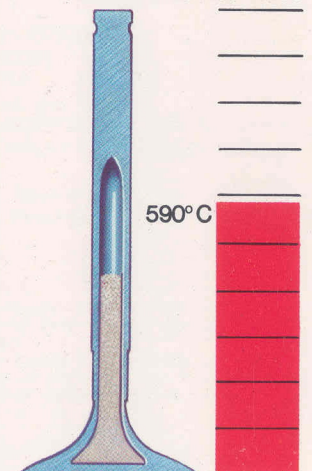

Carburetion: two horizontal twin-choke carburetors.

Distribution: V-Overhead valves directly operated by two overhead camshafts acting through oil bath cups.

Ignition: Golden Lodge spark plugs.

Electrical system: alternator.

Clutch: single dry-plate with progressive engagement. Diaphragm springs. Hydraulically operated.

Gearbox: 5 synchromesh gears and reverse. Floor-mounted gear shift.

Rear axle: anchored to body by two trailing arms

and upper A-bracket; final drive is hypoid type.

Front suspension: independent by transverse A-arm, anti-roll bar and anti-emulsion telescopic hydraulic shock-absorbers.

Rear suspension: coil springs and coaxially mounted anti-emulsion telescopic shock-absorbers; anti roll bar.

Steering: re-circulating ball or worm-and-roller type.

Brakes: servo-operated dual circuit disc brakes on all 4 wheels, with braking power regulator on rear wheels. Hand-brake independent of the main system, acting on drums on the rear wheels.

Cylinders	4 in line
Bore	78 mm
Stroke	82 mm
Cylinder capacity	1570 cc
Power at 6000 rpm	125 CV-SAE (BHP)
Maximum Torque kgm SAE/rpm	15.9/2800
ft. lbs SAE/rpm	115/2800
Wheelbase	2350 mm (7' 8 ¹ / ₂ "
Front track	1324 mm (4' 4")
Rear track	1274 mm (4' 2")
Overall length	4080 mm (13' 4 ¹ / ₂ "
Overall width	1580 mm (5' 2")
Overall height (unladen)	1315 mm (4' 4")
Kerb weight	1020 kg (2250 lbs)
Maximum speed	over 185 k.p.h. (115 mph)
1 km from standing start	33 sec
Tyres	155 HR 15
Optional tyres	165 HR 14
Number of seats	4
Battery	12 V - 50 A/h
Fuel tank capacity	46 litres (10 galls Imp)

Alfa Romeo take part – and always have done – in hundreds of races every year, and every race confirms the high quality of the company's vehicles.

Both the Giulia Super and the GT/Am, whose structure and style are identical to the GT Junior, have competed highly successfully over the last few years in both road and circuit events. The following is a list of their victories, restricted simply to national and international championships.

It is important to underline that all the winning vehicles are not special prototypes but production models. The experience gained with them can thus be applied at once to the production line.

1967

EUROPEAN ROAD CHALLENGE CUP (A. de Adamich)
EUROPEAN MOUNTAIN ROAD CHAMPIONSHIP (I. Giunti)
AUSTRALIAN NEW SOUTH WALES RALLY CHAMPIONSHIP (Chivas-Adcock)
BRAZILIAN MOUNTAIN ROAD CHAMPIONSHIP (E. Zambello)
BELGIAN ROAD SPEED CHAMPIONSHIP (S. Trosch)
FRENCH RALLY AND HILL-CLIMBING TROPHY
GERMAN ROAD SPEED CHAMPIONSHIP (H. Schulze)
GREEK ROAD SPEED CHAMPIONSHIP (« Mavros »)
ITALIAN 1600 cc SALOON TROPHY (« Riccardone »)
SOUTH AFRICAN STANDARD PRODUCTION VEHICLE CHAMPIONSHIP (Van Rooyen)
U.S.A. 2000 cc SEDAN CARS CHAMPIONSHIP (V. Provenzano)

1968

C.S.A.I. 1600 cc G.T. CUP (L. Cecchini)
MOUNTAIN SPORT TROPHY (Bardelli)
GERMAN SPEED CHAMPIONSHIP (H. Schulze)
AUSTRALIAN CHAMPIONSHIP (K. Bartlett)
BELGIAN ROAD CHAMPIONSHIP (J. Desmoulin)
BELGIAN LADIES' CHAMPIONSHIP (Christine)
AUSTRIAN ROAD CHAMPIONSHIP (K. Reisch)
BRAZILIAN ROAD CHAMPIONSHIP (F. Lameirão)
DUTCH 1300/1600 cc ROAD CHAMPIONSHIP (N. Chiotakis)

1969

EUROPEAN ROAD CHALLENGE CUP DIVISION II
— 1600 cc Class (S. Dini)
— 1300 cc Class (E. Pinto)
REPUBLIC OF CZECHOSLOVAKIA CHAMPIONSHIP (D. Welimsky)

SOUTH PACIFIC DIVISIONAL UNITED STATES CHAMPIONSHIP (J. Kline)
S.C.C.A. UNITED STATES' DRIVERS' CHAMPIONSHIP
— Production model Class G (P. Spruell)
— Sedan Class C (H. Theodoracopoulos)
BRAZILIAN CHAMPIONSHIP (M. Fernandes and F. Terra Schmit)
RUMANIAN CHAMPIONSHIP (F. Hainarosie)
ITALIAN 1300 cc SALOON TROPHY (« Ghigo »)
ITALIAN 1600 cc SALOON TROPHY (L. Cecchini)

1970

EUROPEAN ROAD CHAMPIONSHIP (T. Hezemans)
DUTCH ROAD CHAMPIONSHIP (Akersloot)
TRANS-AMERICAN CHAMPIONSHIP for cars under 2 litres (Kwech-Midgley-Everett)
S.C.C.A. AMERICAN DRIVERS' CHAMPIONSHIP Sedan Class B (V. Provenzano)
BELGIAN RALLY CHAMPIONSHIP (P. Y. Bertinchamps)
BELGIAN DRIVERS' CHAMPIONSHIP (« Christine » Beckers)
ITALIAN NATIONAL SPECIAL SALOON TROPHY
— 1300 cc Class (L. Colzani)
— 2000 cc Class (P. De Leonibus)
ITALIAN NATIONAL SPECIAL G.T. TROPHY (L. Cabella)
URUGUAYAN RALLY CHAMPIONSHIP (F. West-C. Assadourian)
CZECHOSLOVAKIAN NATIONAL CHAMPIONSHIP (J. Rosicky)

1971

EUROPEAN ROAD CHAMPIONSHIP (G. Picchi)
AUSTRIAN SPECIAL ROAD CHAMPIONSHIP (K. Wendlinger)



AUSTRIAN PRODUCTION MODEL ROAD CHAMPIONSHIP (G. Koenig)
AUSTRIAN SPEED SPRINT CHAMPIONSHIP (W. Loeffelmann)
BELGIAN ROAD DRIVERS' CHAMPIONSHIP (J. C. Franck)
CANADIAN PRODUCTION MODELS CHAMPIONSHIP (E. Clements)
ITALIAN G.T. SPECIAL MOUNTAIN TROPHY (V. M. Randazzo)
ITALIAN OUTRIGHT SPECIAL ROAD CHAMPIONSHIP (L. Pozzo)
SOUTH AFRICAN MAKES' CHAMPIONSHIP
F.I.S.A. CHALLENGE CUP 1300 cc Class (V. Ciardi)
F.I.S.A. CHALLENGE CUP 1600 cc Class (M. Del Carlo)
ITALIAN SPECIAL SALOON MOUNTAIN TROPHY (M. Litrico)
S.C.C.A. U.S.A. DRIVERS' CHAMPIONSHIP — Class C Sedan (D. Davenport)
DUTCH ROAD CHAMPIONSHIP — up to 1300 cc Class (B. Van der Sluis)
VENEZUELAN OUTRIGHT CHAMPIONSHIP (G. Spadaro)
SOUTH AFRICAN DRIVERS' RALLY CHAMPIONSHIP (Odendaal-Kuun)
C.S.A.I. CUP - Class 1600 cc Special Saloons (Zanetti)
C.S.A.I. CUP - Class 1300 cc Prototype Sports Models (Zanetti)

Details, descriptions and illustrations are for information purposes only, as the products may vary for any reason, including constructional requirements.

Alfa Romeo reserves the right to modify its products in any way. Some of the items described or shown in this brochure are optional. For information about optional extras, please consult our local price list.

Realizzazione CBC, Milano.

Printed in Italy. 72 7 C 101 ILTE - Torino

